

TELL EL-MASKHUTA  
POTTERY FROM THE AREAS ADJACENT TO THE WALLS  
(EXCAVATION CAMPAIGN 2016)

Maria Cristina Guidotti - Consiglio Nazionale delle Ricerche -  
Istituto di Scienze del Patrimonio Culturale

*The first excavation campaign at Tell el-Maskhuta was carried out along the walls of the site. The surveys have yielded the pottery presented here, coming from the Areas 1, 2, 3 and 4. The material is mainly domestic; the dating of the pottery is from the Late Period and the Ptolemaic Period. It should be noted also the presence of many fragments of Tell el Yahudiyeh Ware and imported amphorae.*

Keywords: Tell el-Maskhuta; pottery; Tell el-Yahudiyeh Ware; Late Period; Ptolemaic Period

In November 2016, the first excavation campaign was conducted at the site of Tell el-Maskhuta,<sup>1</sup> where some surveys were also carried out along the remains of the massive walls that characterize the site.<sup>2</sup> The surveys have yielded very fragmentary ceramic material, a selection of which made on the excavation is presented here.<sup>3</sup>

#### 1. POTTERY FROM AREA 4<sup>4</sup>

The excavation survey conducted in Area 4, along the Northern Square Enclosure Wall (SEW-N), has returned scarce and fragmentary material, which can be dated to the Late Period; we can find comparisons with pottery dating to the XXV-XXVI dynasty.<sup>5</sup> A fragment of the rim with a handle of an amphora could belong to an imported specimen of Aegean production.<sup>6</sup>

1 – Fragment of large jar rim<sup>7</sup>

65/16 – Area 4 US5

Diam. 24 cm, red Nile silt fabric (LIII), red paint outside and partly inside

2 – Fragment of jar rim<sup>8</sup>

67/16 – Area 4 US5

Diam. 14 cm, brown Nile silt fabric (LIII)

---

<sup>1</sup> Capriotti Vittozzi - Angelini - Iacoviello 2018.

<sup>2</sup> Angelini *et al.* 2020, 82, fig. 3.

<sup>3</sup> The abbreviations of the measures are diam. (mouth or base diameter) and h. (height). The abbreviations used for the fabrics are L (Nile silt clay) and M (marl clay). The index from I to V indicates the groundmass of the fabric.

<sup>4</sup> Capriotti Vittozzi - Angelini - Iacoviello 2018, 225.

<sup>5</sup> Comparisons in Laemmel 2012, pls. 46-47; French - Ghaly 1991, 105, n.18. Regarding the syro-palestinian amphorae and the local imitations see Hamza 1997, 81-82, pls. X-XII.

<sup>6</sup> See Gratien 1997, 75, pl. II:8-140.

<sup>7</sup> Angelini *et al.* 2020, 74, n. 1.

<sup>8</sup> Angelini *et al.* 2020, 74, n. 2.

3 – Upper part of Syro-Palestinian amphora with two vertical handles<sup>9</sup>  
66/16 – Area 4 US5  
Diam. 12 cm, white/yellowish fine clay

## 2. POTTERY FROM AREA 2<sup>10</sup>

The Area 2 excavation survey was also conducted along the Northern Square Enclosure Wall (SEW-N), at the point where it crosses the Western Extension Wall (NEW-W). The pottery collected can be dated to the period between the end of the Late Period and the Ptolemaic Period. Much material appears completely blackened. Many fragments of Tell el-Yahudiyeh Ware<sup>11</sup>, which date back to the Second Intermediate Period/ Hyksos Period, come from this area: they are the evidence of previous site frequentations, but also of the great upheavals that the stratification of the site itself has undergone. The fragment of a juglet n. 9 probably belonged to a jar similar to that of fig. 1, found in the same area in US7<sup>12</sup>. Fragments n. 6, belonging to one or more crucibles, could also be dated to this same age<sup>13</sup>. For the rest of the material we can find comparisons with pottery found at various sites in Lower Egypt<sup>14</sup>. Fragment n. 4 could be from a much later period, dated to the first centuries AD:<sup>15</sup> like some other fragments belonging to amphorae, it probably arrived from the upheavals of the upper layers.

4 – Part of cooking pot<sup>16</sup>  
48/16 – Area 2 US7  
Diam. 28 cm, brown Nile silt fabric (LIII)

5 – Ring base of bowl<sup>17</sup>  
49/16 – Area 2 US7  
Diam. base 6.6 cm, brown Nile silt fabric (LIII), surface completely blackened

6 – Fragments of one or more crucible<sup>18</sup>  
51/16 – Area 2 US2  
Diam. base 14 cm, red Nile silt fabric with inclusions and black core (LV), remains of metal smelting inside

7 – Fragment of jar rim with horizontal handle<sup>19</sup>  
50/16 – Area 2 US7  
Diam. 13 cm, red Nile silt fabric (LII), surface completely blackened

8 – Fragment of large jar or amphora<sup>20</sup>  
52/16 – Area 2 US2  
7.2×6.8 cm, white/yellowish marl fabric (MII), ring and comb incised decoration

<sup>9</sup> Angelini *et al.* 2020, 74, n. 3.

<sup>10</sup> Capriotti Vittozzi - Angelini - Iacoviello 2018, 225-226.

<sup>11</sup> Regarding the Tell el-Yahudiyeh Ware see Aston - Bietak eds. 2011; Bietak - Aston 2019; Vilain 2019; a particular reference to the Tell el-Yahudiyeh Ware of Tell el-Maskhuta in Ksiezak 2017.

<sup>12</sup> Capriotti Vittozzi - Angelini - Iacoviello 2018, 226.

<sup>13</sup> See Holladay 1982, 79, nos. 1-4.

<sup>14</sup> French 1992; Marchand 1996; Laemmel 2012; Smoláriková 2014.

<sup>15</sup> See Wodzińska 2010b, 144-145, nos. 217-220.

<sup>16</sup> Angelini *et al.* 2020, 75, n. 6.

<sup>17</sup> Angelini *et al.* 2020, 75, n. 5.

<sup>18</sup> Angelini *et al.* 2020, 75, n. 7.

<sup>19</sup> Angelini *et al.* 2020, 75, n. 4.

<sup>20</sup> Angelini *et al.* 2020, 75, n. 8.

9 – Fragment of little jug (Tell el-Yahudiyeh Ware, combed group)<sup>21</sup>

55/16 – Area 2 US1

9×8.5 cm, dark brown fine clay, comb incised decoration

10 – Upper part of Syro-Palestinian amphora with two vertical handles<sup>22</sup>

54/16 – Area 2 US2

Diam. 11 cm, white/yellowish fine clay

11 – Handle of large lid<sup>23</sup>

53/16 – Area 2 US2

H. 7.5 cm, red Nile silt fabric coarse with black core (LIV)

12 – Rim and neck of little jug with a vertical handle (Tell el-Yahudiyeh Ware)<sup>24</sup>

58/16 – Area 2 US7

Diam. 3.8 cm, black fine clay

13 – Fragment of little jug (Tell el-Yahudiyeh Ware)<sup>25</sup>

57/16 – Area 2 US7

5.8×6 cm, brown fine clay with black core, incised punctured decoration with traces of white filling

14 – Ring base of little jug (Tell el-Yahudiyeh Ware)<sup>26</sup>

56/16 – Area 2 US1

Diam. base 3 cm, brown fine clay, incised punctured decoration with traces of white filling

### 3. POTTERY FROM AREA 3<sup>27</sup>

Area 3 has been the subject of a superficial survey, which has returned scarce and fragmentary material, of different periods. The fragments of a small dish in faience n. 15 in fact refer to the Roman Period<sup>28</sup>, while the *unguentarium* n. 19<sup>29</sup>, the fragmentary neck of an amphora n. 21<sup>30</sup> and some fragments of amphorae with painted *tituli* (fig. 2)<sup>31</sup> are dated to the Ptolemaic Period<sup>32</sup>.

15 – Fragments of faience dish

18/16 – Cleaning western extension wall (NEW-W)

Diam. base 14.2 cm, faience light green/blue, white core

16 – Fragment of little alabaster dish (modern?)

62/16 – Cleaning northern square enclosure wall (SEW-N)

Diam. 12.3 cm

17 – Upper part of jar

64/16 – Cleaning northern square enclosure wall (SEW-N)

Diam. 12 cm, red Nile silt fabric with brown core (LIII), red polished slip outside and on the rim

<sup>21</sup> Angelini *et al.* 2020, 75, n. 9.

<sup>22</sup> Angelini *et al.* 2020, 75, n. 10.

<sup>23</sup> Angelini *et al.* 2020, 75, n. 11.

<sup>24</sup> Angelini *et al.* 2020, 75, n. 12.

<sup>25</sup> Angelini *et al.* 2020, 75, n. 13.

<sup>26</sup> Angelini *et al.* 2020, 76, n. 14.

<sup>27</sup> Angelini *et al.* 2020, 70-71.

<sup>28</sup> Suggestion of Flora Silvano, whom I thank here.

<sup>29</sup> See Ballet 1997, 52-53, nos. 15 and 19; Wodzińska 2010b, 31, no. 5.

<sup>30</sup> See Marangou - Marchand 2007, 288, fig. 122.

<sup>31</sup> 59/16, with red *lambda*, and 60/16.

<sup>32</sup> Capriotti Vittozzi - Angelini - Iacoviello 2018, 226, notes 243-245.

- 18 – Bottom of little vase  
63/16 – Cleaning northern square enclosure wall (SEW-N)  
Diam. base 7.2 cm, red/brown Nile silt fabric (LIII)
- 19 – Part of *unguentarium*  
69/16 – Western extension wall (NEW-W)  
H. 5.7 cm, light brown Nile silt fabric (LII)
- 20 – Handle of cooking pot (prob.)  
61/16 – Cleaning western extension wall (NEW-W) near Area 1  
Length 12.2 cm, red Nile silt fabric (LII)
- 21 – Fragment of neck amphora  
68/16 – Western extension wall (NEW-W) near Area 1 US2  
Diam. 14 cm, light red fine clay, white slip outside

#### 4. POTTERY FROM AREA 1 “FOUNDATION DEPOSIT”<sup>33</sup>

The pottery found during the investigation of a so-called “foundation deposit” in Area 1 can be dated in a quite limited way between the end of the Late Period and the beginning of the Ptolemaic Period. The presence of numerous fragments of bread trays, burnt bones and blackened pottery sherds (figs. 3 and 4), suggests a small domestic landfill, perhaps of a living setting leaning against the walls. The fragments of bread trays have a large thickness, that exceeds the 3 centimetres and are dated to the Late Period<sup>34</sup>, like the fragment n. 33<sup>35</sup>. The fragment of bowl n. 29 and the neck of jar n. 30 find comparisons with material found in Tebtynis<sup>36</sup> dating from the end of the Late Period to the beginning of the Ptolemaic Period. The fragment of amphora n. 34, with the Greek letters *rho* and *alfa* painted in red, confirms the dating of the so-called “foundation deposit”. During the investigations in the areas around this “foundation deposit” we have also found two juglets of Tell el-Yahudiyeh Ware (nos. 31 and 32), for which reference is made in my conclusions.

- 22 – Bottom of little vase (bread mold?)  
75/16 – Area 1 US16  
H. 4 cm, red Nile silt fabric with grey core (LIII)
- 23 – Fragment of bread tray  
76/16 – Area 1 US16  
H. 3 cm, red Nile silt fabric coarse (LIV), largely blackened
- 24 – Fragment of bread tray  
77/16 – Area 1 US16  
Base thickness 1.6 cm, brown Nile silt fabric coarse (LIV/LV)
- 25 – Fragment of bread tray  
78/16 – Area 1 US21  
Thickness max 4.8 cm, red Nile silt fabric coarse (LV)

<sup>33</sup> Capriotti Vittozzi - Angelini - Iacoviello 2018, 226-227.

<sup>34</sup> Wodzińska 2010a, 273, no.139; 2013, 101, fig. 5.

<sup>35</sup> See Hamza 1997, 84, pl. XI, fig. 10; Wodzińska 2010a, 234, no. 30; Laemmel 2012, pl. 56:272.

<sup>36</sup> See Marchand 1996, 174, figs. 1-2, 182, fig. 25.

26 – Fragment of flat modeled rim of dish

5/16 – Area 1 US21a+b

H. 2.5 cm, red Nile silt fabric with black core (LIII/LIV), red paint inside and outside

27 – Base of dish

73/16 – Area 1 US20

Diam. base 6 cm, light brown Nile silt fabric (LIII/LIV), red paint inside

28 – Fragment of little cup rim

72/16 – Area 1 US20

H. 11 cm, red Nile silt fabric (LIII)

29 – Fragment of bowl rim

74/16 – Area 1 US20

H. max 2.7 cm, light brown Nile silt fabric (LIII), red paint inside

30 – Fragment of jar rim

3/16 – Area 1 US20

Diam. 11 cm, red/orange Nile silt fabric (LIII), largely blackened inside and outside

31 – Little jug (Tell el-Yahudiyeh Ware)

6/16 – Area 1 Cleaning west wall

H. max 8.3 cm, dark brown fine clay, incised punctured decoration with traces of white filling

32 – Part of little jug (Tell el-Yahudiyeh Ware)<sup>37</sup>

71/16 – Area 1 Cleaning west wall

H. max 8.2 cm, dark brown fine clay, incised punctured decoration with white filling

33 – Fragment of syro-palestinian amphora rim

2/16 – Area 1 US20

Diam. 12 cm, yellowish fine clay

34 – Fragment of amphora with *titulus*

1/16 – Area 1 Deposit US21a

H. max 11.2 cm, white/yellowish fine clay, *titulus* red painted

## 5. CONCLUSIONS

The material from the surveys carried out in the areas adjacent to the walls is mainly domestic: it consists of table, cooking and storage vases. The pottery and its wide chronological range seem suggest what had already emerged from the archaeological excavations of Holladay, with a concentration of material dating from the Late Period to the Ptolemaic Period. Some fragments can be dated to the Roman Period, evidence of the site frequentation up to this period.

The pottery found in Area 4 is dated to the Late Period, while the one found in Area 3 has a very varied dating, from the Late Period to the Roman Period.

The zone at the point where the Northern Square Enclosure Wall (SEW-N) crosses the Western Extension Wall (NEW-W) (Area 2 and the “foundation deposit”) is characterized by blackened material, probably due to domestic fireplaces, of dwellings leaning against the walls. The dating of the pottery is between the Late Period and the Ptolemaic Period, with the presence of many fragments of Tell el Yahudiyeh Ware and of the Roman Period. The numerous fragments of imported amphorae are the evidence of the intense activity of

<sup>37</sup> Angelini *et al.* 2020, 88, fig. 12, 99, figs. 22-23.

commercial exchanges; it is the characteristic of a border site on one of the most important routes of communication between Egypt and the Near East.

It should be noted that the fragments of Tell el Yahudiyeh Ware were found especially in the areas around the point where the Fortress Wall 1 crosses the Fortress Wall 2, and not in the other areas along the walls. Perhaps this is the evidence of where the Hyksos Period settlement originally stood.

#### REFERENCES

- ANGELINI, A. - CAPRIOTTI VITTOZZI, G. - IACOVIELLO, A. - GUIDOTTI, M.C.  
2020 Il sito di Tell el-Maskhuta tra novità, interrogativi e prospettive: *Ricerche Italiane e Scavi in Egitto VIII* (2020), pp. 66-94.
- ASTON, D. - BIETAK, M. (eds.)  
2011 *Tell el-Daba VIII: The Tell el-Yahudiyeh Ware and its Classification*, Wien 2011.
- BALLET, P.  
1997 Tell al-Moufarig: *Cahiers de la Céramique Egyptienne* 5 (1997), pp. 47-55.
- BIETAK, M. - ASTON, D.  
2019 Middle Bronze Age II Local and Imported Tell el-Yahudiyeh Ware: S. GITIN (ed.), *The Ancient Pottery of Israel and its Neighbors from the Middle Bronze Age through the Late Bronze Age* (Vol. 3), Jerusalem 2019, pp. 137-143.
- CAPRIOTTI VITTOZZI, G. - ANGELINI, A. - IACOVIELLO, A.  
2018 Le prime tre campagne archeologiche a Tell el-Maskhuta (2015/2016): *Ricerche Italiane e Scavi in Egitto VII* (2018), pp. 221-232.
- FRENCH, P.  
1992 A preliminary study of pottery in Lower Egypt in the Late Dynastic and Ptolemaic Periods: *Cahiers de la Céramique Egyptienne* 3 (1992), pp. 83-93.
- FRENCH, P. - GHALY, H.  
1991 Pottery chiefly of the Late Dynastic Period, from excavations by the Egyptian Antiquities Organisation at Saqqara: *Cahiers de la Céramique Egyptienne* 2 (1991), pp. 93-124.
- GRATIEN, B.  
1997 Tell el-Herr sondage stratigraphique: *Cahiers de la Céramique Egyptienne* 5 (1997), pp. 71-80.
- HAMZA, O.  
1997 Qedua: *Cahiers de la Céramique Egyptienne* 5 (1997), pp. 81-102.
- HOLLADAY, J.  
1982 *Tell el-Maskhuta. Preliminary Report on the Wadi Tumilat Project 1978-1979* (Cities of the Delta, part III), Malibu 1982.
- KSIEZAK, A.  
2017 Tell el-Yahudiyeh Ware in the Eastern Nile Delta – Production, distribution, and fabric use specialization at the site of Tell el-Maskhuta during the Second Intermediate Period: *American School of Oriental Research. November 15-18, 2017 Annual Meeting*, Boston 2017.
- LAEMMEL, S.  
2012 *Le matériel céramique du Temple d'Horus de Mesen et des sondages au centre du tell Sâh el-Hagar de la Troisième Période Intermédiaire à la Basse Époque* (Cahier de la Société Française des Fouilles de Tanis, 4), Paris 2012.

MARCHAND, S.

1996 La céramique du IV siècle av. J.C. découverte à Tebtynis: *Cahiers de la Céramique Egyptienne* 4 (1996), pp.171-188.

MARANGOU, A. - MARCHAND, S.

2007 Conteneurs importés et égyptiens de Tebtynis (Fayoum) de la deuxième moitié du IV<sup>e</sup> siècle av. J.-C. au X<sup>e</sup> siècle apr. J.-C. (1994-2002): *Cahiers de la Céramique Egyptienne* 8 (2007), pp. 239-294.

SMOLÁRIKOVÁ, K.

2014 Ceramics from trench NA: N. SPENCER (ed.), *Kom Firin II: The Urban Fabric and Landscape*, London 2014, pp. 272-275.

VILAIN, S.

2019 The foreign trade of Tell el-Dab'a during the Second Intermediate Period: another glance at imported ceramics under Hyksos rule: J. MYNÁŘOVÁ - M. KILANI - S. ALIVERINI (eds.), *A Stranger in the House – the Crossroads III* (Proceedings of an International Conference on Foreigners in Ancient Egyptian and Near Eastern Societies of the Bronze Age held in Prague, September 10–13, 2018), Prague 2019, pp. 387-404.

WODZIŃSKA, A.

2010a *A Manual of Egyptian Pottery. Volume 3: Second Intermediate Period-Late Period* (AERA Field Manual Series 1), Boston 2010.

2010b *A Manual of Egyptian Pottery. Volume 4: Ptolemaic Period-Modern* (AERA Field Manual Series 1), Boston 2010.

2013 Tell el-Retaba, season 2010: pottery report: *Polish Archaeology in the Mediterranean* 22 (2013), pp. 96-103.

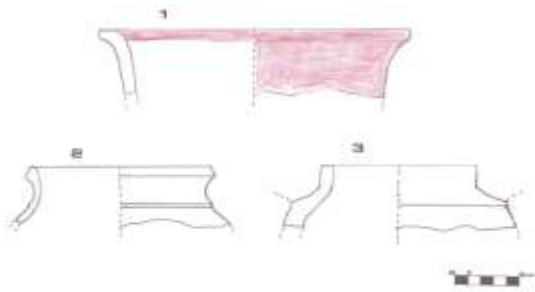

Nos. 1, 2 and 3

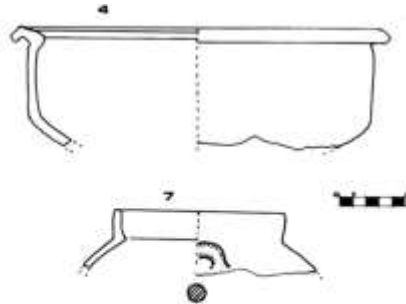

Nos. 4 and 7

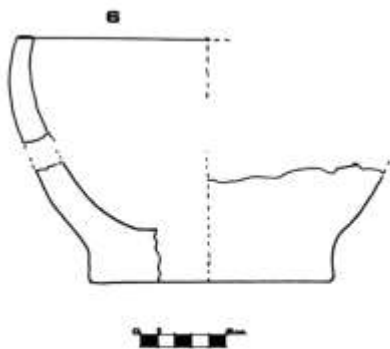

N. 6

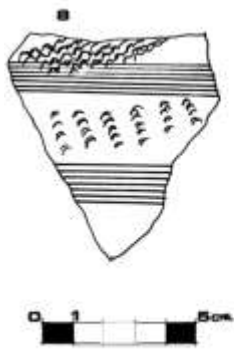
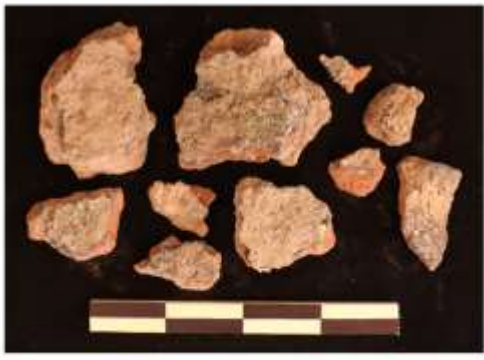

N. 8



N. 9

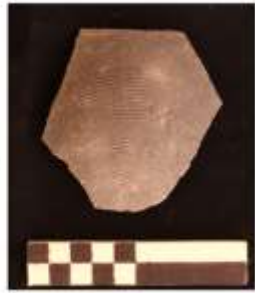



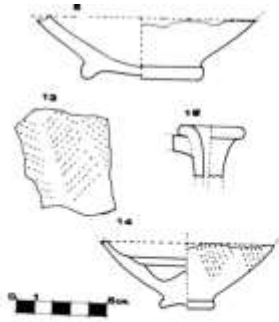

Nos. 5, 12, 13 and 14

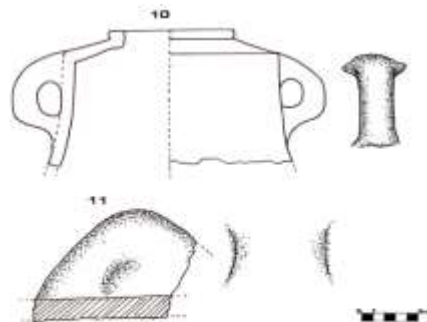

Nos. 10 and 11

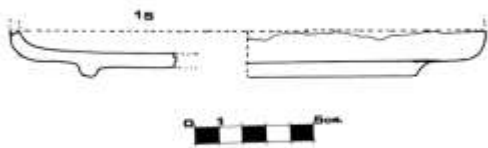

N. 15



N. 15a



N. 15b



N. 15c

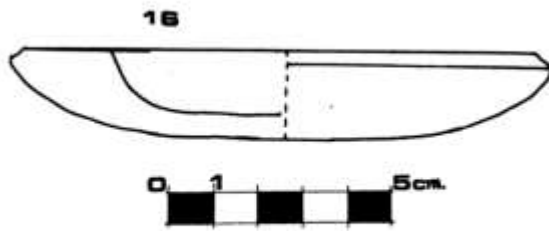

N. 16

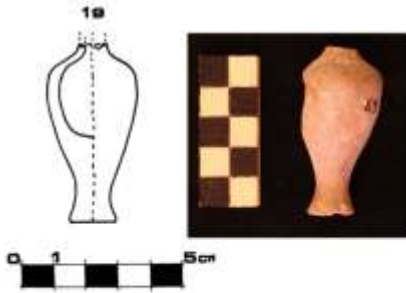

N. 19

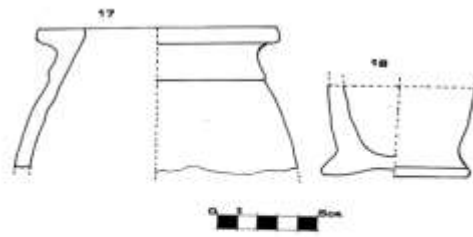

Nos. 17 and 18

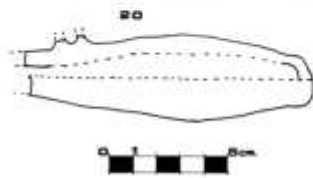

N. 20

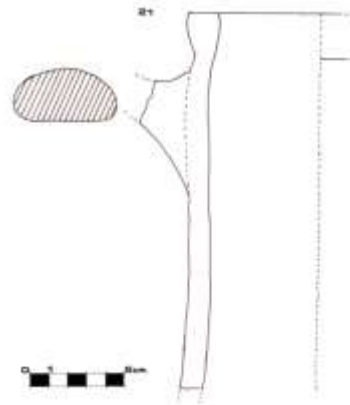

N. 21

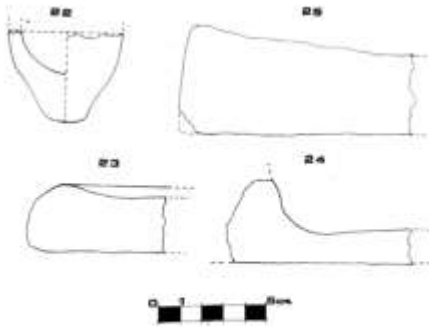

Nos. 22, 23, 24 and 25

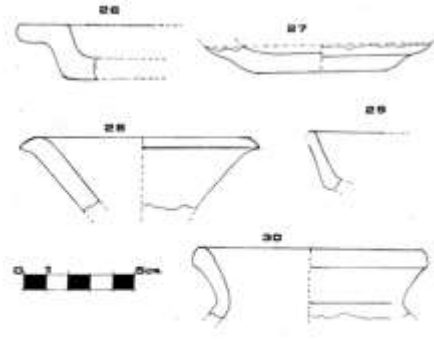

Nos. 26, 27, 28, 29 and 30

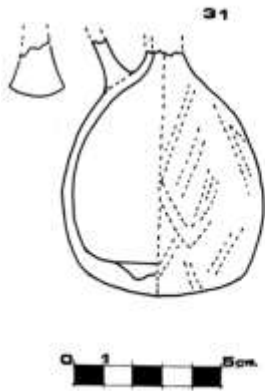

N. 31

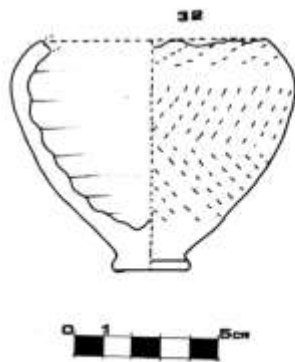

N.32



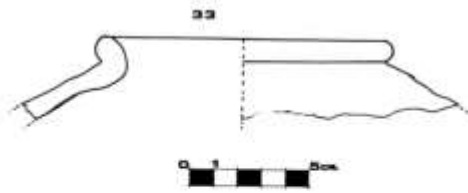

N. 33

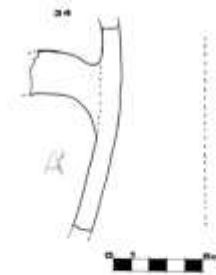

N. 34



Fig. 1



Fig. 2



Fig. 3



Fig. 4